

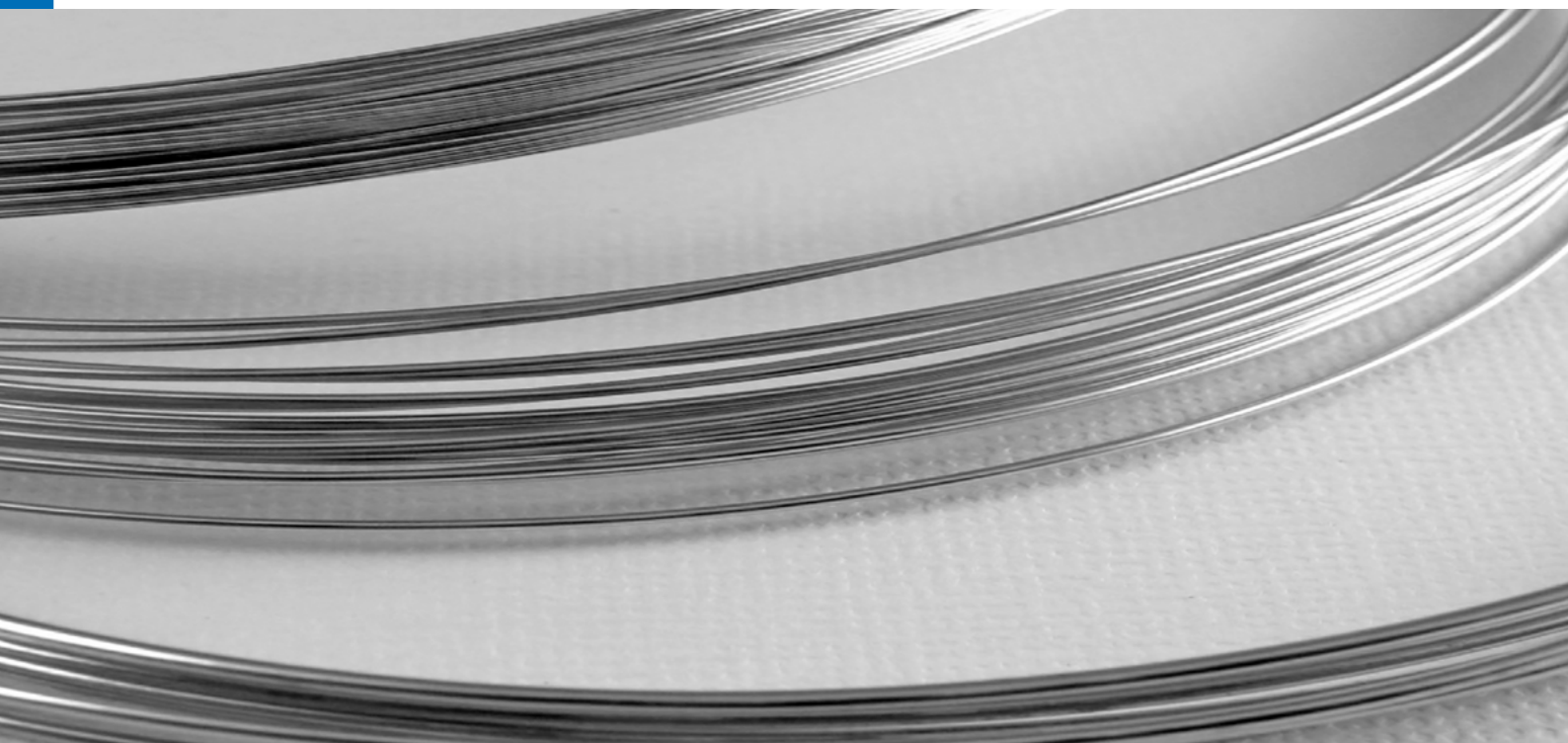

GUMMETAL®

a wire like no other.



Thinking ahead. Focused on life.



GUMMETAL®

JM ORTHO CORPORATION which has been committed to making continuous innovations in the Orthodontic field successfully developed the **GUMMETAL®** world-class premium orthodontic wire, which has unique characteristics, manufactured with exceptional craftsmanship.

GUMMETAL® is an entirely new Ti-Nb based beta titanium alloy developed by Toyota Central R&D Labs, a Toyota think tank, which displays the good properties of rubber.

GUMMETAL® is the world's first alloy that has low Young's modulus and high strength at the same time. This unique qualities cannot be obtained from any other conventional metallic materials.

Its properties are ideal for orthodontic wire: high stored energy, good formability, low stiffness, low surface friction, large springback, bio-compatibility and environmental stability.

GUMMETAL® – a wire like no other.



Unique Features

Ultra Low Young's Modulus yet with Ultra High Strength

GUMMETAL is **SOFT** but **STRONG**. Therefore, easier adaptation of a full sized wire for 3 dimensional control from early phase of treatment is possible while providing

optimum orthodontics force that is moderate and continuous, resulting faster teeth movement, alleviating pains.

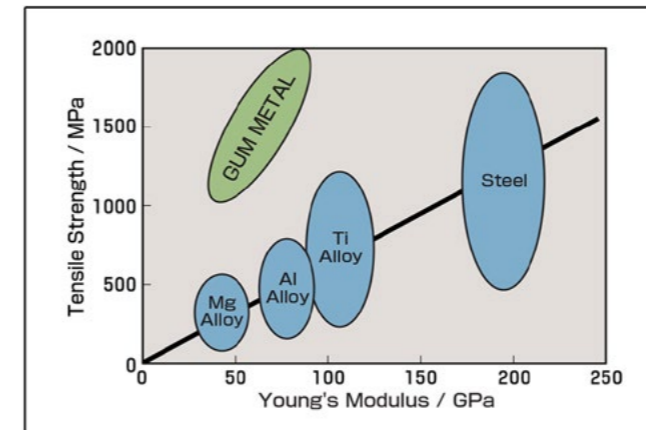

Key characteristics of several conventional biocompatible metal alloys and GUMMETAL				
Metal for dental use	Conventional metal	Main elements	Young's modulus GPa	Tensile strength MPa
Noble metal	12%Au-Ag-Pd alloy	Au-Ag-Pd	>250	900
Stainless steel	SUS316	Fe-Cr-Ni-Mo	200	860
Co-Cr alloy	ASTM F562	Co-Cr-Ni-Mo	170	1000
Titanium	Pure Titanium	Ti	102	270
Ni-Ti alloy	Nitinol	Ti-Ni	105	700
α+β Titanium alloy	ASTM F136	Ti-Al-V	85	860
Ti-Nb alloy	GUMMETAL	Ti-Nb-Ta-Zr	45	1100

(Cr, Ni, V are cytotoxic)

Ultra High & Nonlinear Elasticity with Super plasticity (no work-hardening)

Super-elastic nature of **GUMMETAL** is one digit higher in elastic deformation compared to general metallic materials. Young's Modulus changes depending on amount of distortion and performs the Nonlinear behavior, a characteristic similar to GUM or rubber. It does not show work-hardening at all under any kind of hard working, continuous deformation is possible to any desired level. It results no stress change by adjustment while ensuring less breakage in the mouth. **GUMMETAL** is **FLEXIBLE** but **FORMABLE**.

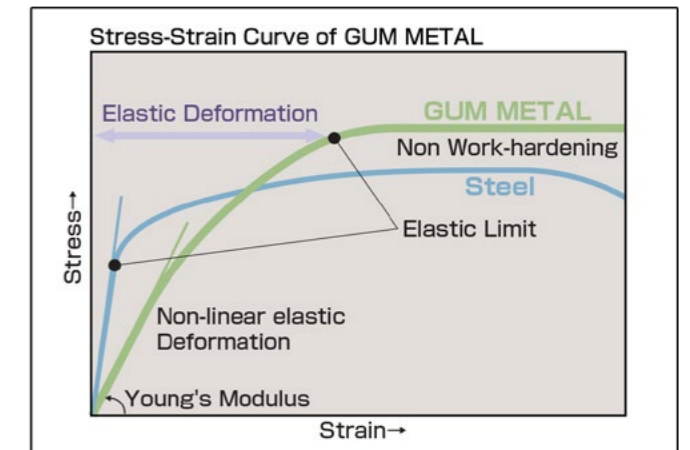

High Spring Back and no Hysteresis

Results to maintain easier control of orthodontic force with high resilience as well as loading force that is the same as unloading force.

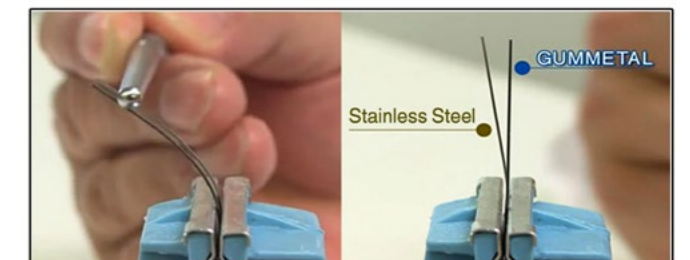

This unique feature maintains a stable wire bending while ensuring wire springback bringing along the teeth into correct position.

Low Friction

Results efficient teeth movement and is suitable for sliding mechanics.

The friction between GUMMETAL surface and metal brackets is just half of other titanium wires.

Biocompatible

All the constituent atomic elements of the alloy are biocompatible and non-toxic. GUMMETAL is Nickel free alloy for Nickel sensitive patients.

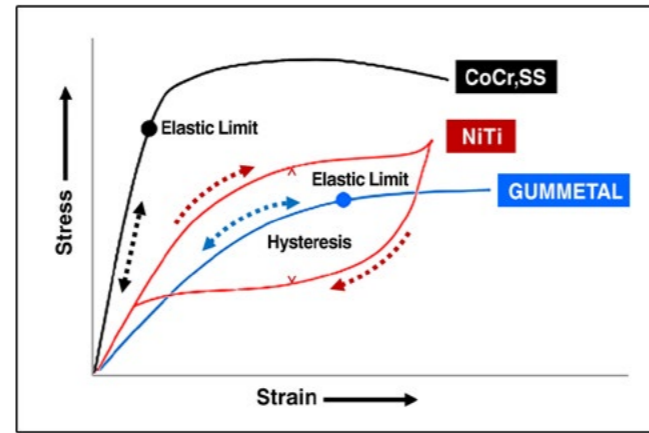

GUMMETAL – Straight Wire (cut)

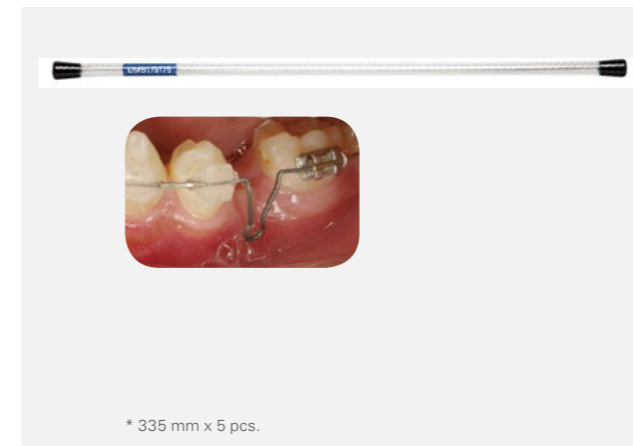

Wire Size	Product Code*
.012	GMC12
.014	GMC14
.016	GMC16
.018	GMC18
.016 x .016	GMC1616
.016 x .022	GMC1622
.017 x .022	GMC1722
.017 x .025	GMC1725
.0175 x .0175	GMC175175
.018 x .022	GMC1822
.018 x .025	GMC1825
.019 x .025	GMC1925
.021 x .025	GMC2125

* 335 mm x 5 pcs.

Product Line Up

GUMMETAL – Archwire Natural Form

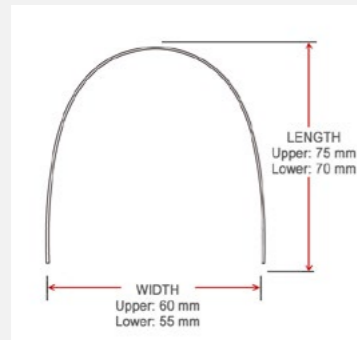

* 5 Solo Packs

Wire Size	Product Code*	
	Upper	Lower
.014	GM14UE	GM14LE
.016	GM16UE	GM16LE
.018	GM18UE	GM18LE
.016 x .016	GM1616UE	GM1616LE
.016 x .022	GM1622UE	GM1622LE
.017 x .022	GM1722UE	GM1722LE
.017 x .025	GM1725UE	GM1725LE
.018 x .022	GM1822UE	GM1822LE
.018 x .025	GM1825UE	GM1825LE
.019 x .025	GM1925UE	GM1925LE
.021 x .025	GM2125UE	GM2125LE

GUMMETAL – Straight Wire (rolled)



* Available in plastic tube for protection

Wire Size	Length (m)	Product Code
.028	3.2 m	GMR28
.032	2.5 m	GMR32
.036	2.0 m	GMR36
.040	1.6 m	GMR40

GUMMETAL – White Archwire

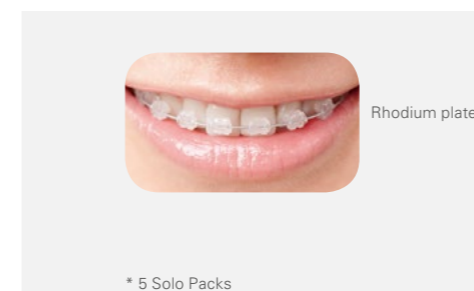

* 5 Solo Packs

Wire Size	Product Code*	
	Upper	Lower
.016 x .016	GMW1616UE	GMW1616LE
.016 x .022	GMW1622UE	GMW1622LE
.017 x .022	GMW1722UE	GMW1722LE
.017 x .025	GMW1725UE	GMW1725LE
.018 x .022	GMW1822UE	GMW1822LE
.018 x .025	GMW1825UE	GMW1825LE
.019 x .025	GMW1925UE	GMW1925LE

GUMMETAL – Arch Blanks (for lingual)

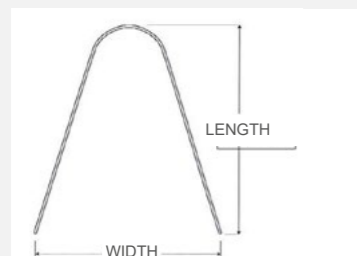

* 5 Solo Packs

Wire Size	Width (mm)	Length (mm)	Diameter of anterior section	Product Code*
.016 x .016	62	65	26 Ø	GM1616-1E
.016 x .022	62	65	26 Ø	GM1622-1E
.0175 x 0.175	62	65	26 Ø	GM175175-1E
.0175 x .0175	68	68	32 Ø	GM175175-4E
.017 x .025	62	65	26 Ø	GM1725-1E
.018 x .022	62	65	26 Ø	GM1822-1E

GUMMETAL – White Straight Wire (rolled)

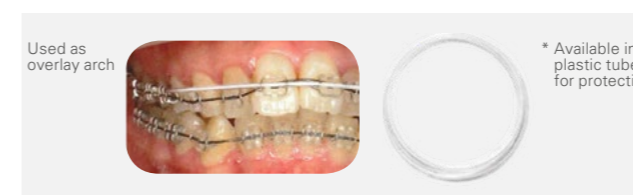

* Available in plastic tube for protection

Wire Size	Length (m)	Product Code
.032	2.5 m	GMWR32
.036	2.0 m	GMWR36

Other Ortho Products

Diagnoses & Imaging

Veraviewepocs 2D CP

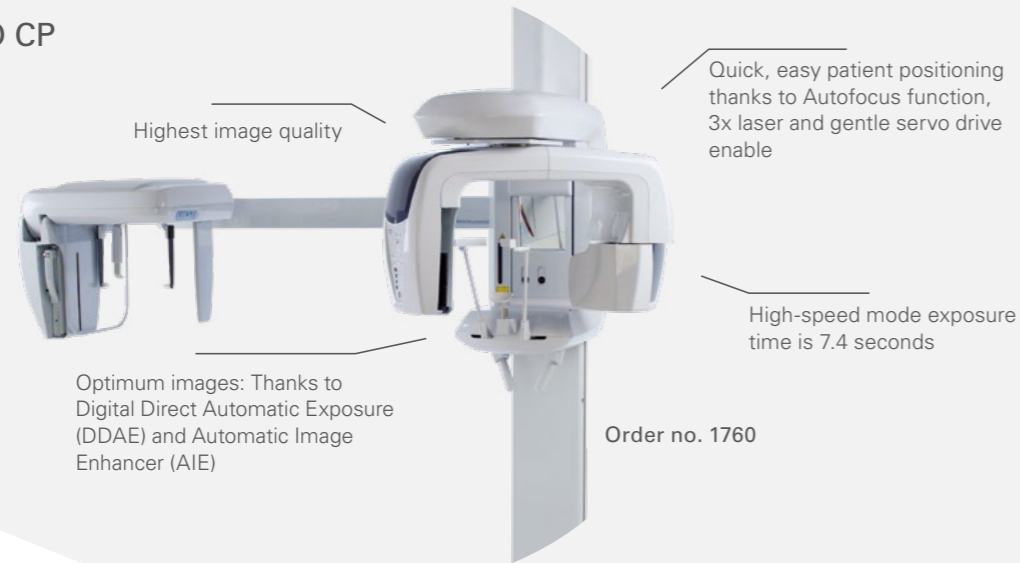

Handpiece & Instruments

PenCure 2000 – Curing light



TorqTech and Ortho-Strips



Treatment Units

SIGNO G10 II S

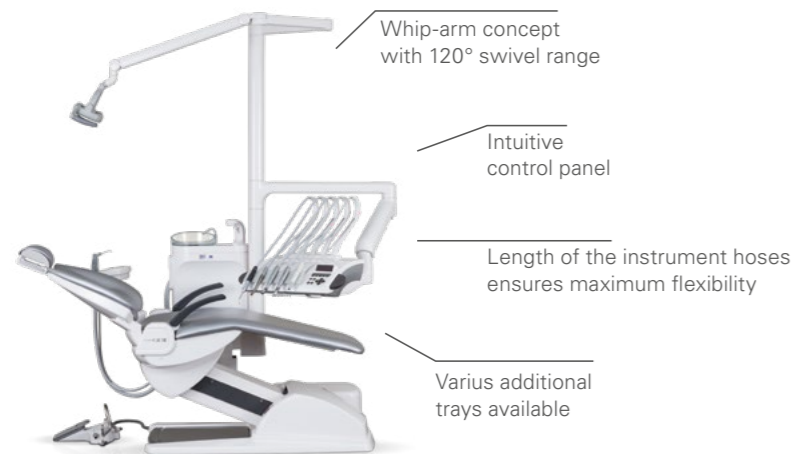

Order no. 3420-SA

EMCIA Ortho

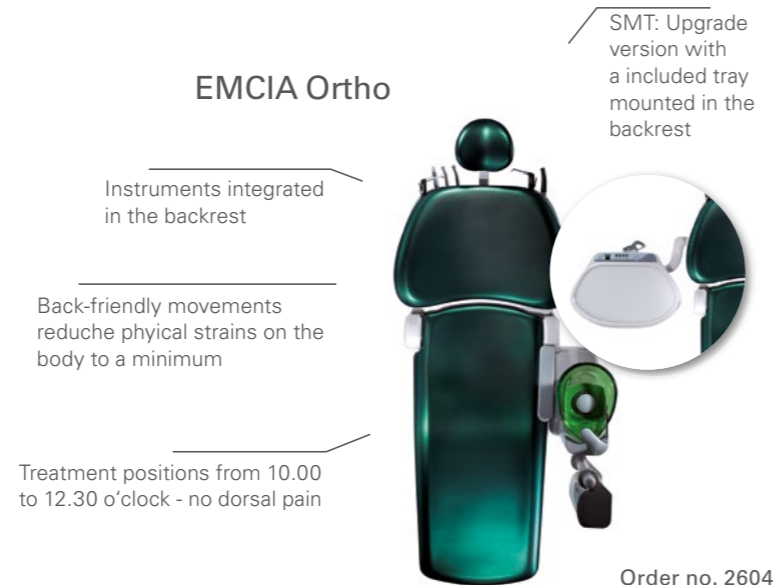

Oral Mirror MXS

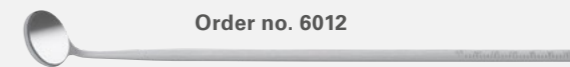

Orthodontic Demonstration Models

P4D-407F

Demonstration upper and lower models, with malocclusion caused by thumbsucking

Order no. 8620



P3B-706

Adult tooth brushing instruction model with permanently affixed orthodontic brackets and arch wire.

Order no. 8614



D50D-JME9

Orthodontic demonstration model, upper and lower jaw, with D-articulator, teeth with orthodontic appliances (brackets and arch wires).

Order no. 8356



Demonstration tooth brush



Interdental brush



Diagnostic and Imaging Equipment

Treatment Units

Handpieces and Instruments

Endodontic Systems

Laser Equipment

Laboratory Devices

Auxiliaries



Distribution

J. MORITA EUROPE GMBH

Justus-von-Liebig-Str. 27a

63128 Dietzenbach

Germany

T +49. 6074. 836 0, F +49. 6074. 836 299

www.morita.com/europe

Development and Manufacturing

JM ORTHO CORPORATION

Ochanomizu-Kyoun Building 14F, 2 Kanda-Surugadai 2-chome, Chiyoda-ku,

Tokyo 101-0062

Japan

T +81. 3. 5281 4711 F +81. 3. 5281 4716

www.jmortho.co.jp